

Flexible Capillary Tube & Refrigerant Hose

RH is designed for the flow of refrigerants, gases and oil in air conditioning and refrigerator system. Flexible and durable RH contributes to simple and convenient working and non-leakage operation.

- Suitable for all CFC, HFC and HCFC refrigerants, natural gases and ammonia
- Working temperature range is from -40°C to +130°C
- Durable under high pressure
- Easy to crimp hose and fittings by its tools

Special Note

- Do not use in injection line
- Completely assembled products are supplied.
(Please consult with requirements.)

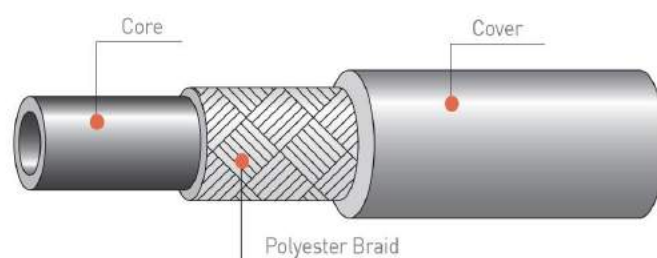

Flexible Capillary Tube

Specifications

Model No.	ID (mm)	OD (mm)	Max. Working Pressure MPa(bar)	Min. Burst Pressure MPa(bar)	Min. Bend Radius (mm)	Weight (g/m)	Color
RH -01	2.5	5.5	19.6(200)	78.4(800)	15	22	Black
RH -02	3.6	7.0	9.8(100)	39.2(400)	20	45	Black

Refrigerant Hose

Specifications

Model No.	ID (mm)	OD (mm)	Max. Working Pressure MPa(bar)	Min. Burst Pressure MPa(bar)	Min. Bend Radius (mm)	Weight (g/m)	Color
RH -04	6.3	10.4	5(50)	25(250)	30	60	Black
RH -06	9.6	14.0			60	87	Black
RH -08	12.9	17.7			80	120	Black
RH -10	15.9	20.9			120	155	Black
RH -12	19.1	24.9			160	194	Black

Fitting by Hand Plier

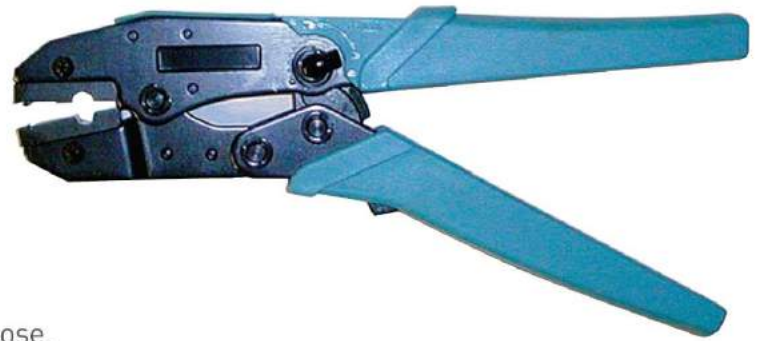

Hand Plier is a manual tool for only RH-01 hose.

Straight Kit

[RH-01]

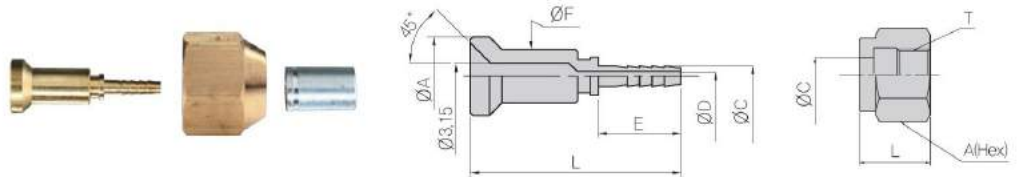

Specifications

Model No.	Hose	A (mm)	C (mm)	D (mm)	E (mm)	F (mm)	L (mm)	Socket	Material
RHN-01	RH-01	9.5	2.6	1.0	10.0	6.5	26.5	RHS-01	Brass

Model No.	Hose	A (HEX)	C (mm)	L (mm)	T [Thread]	Material
N7/16	RH-01	17	6.7	15	UNF7/16-20	Brass

Elbow Kit

[RH-01]

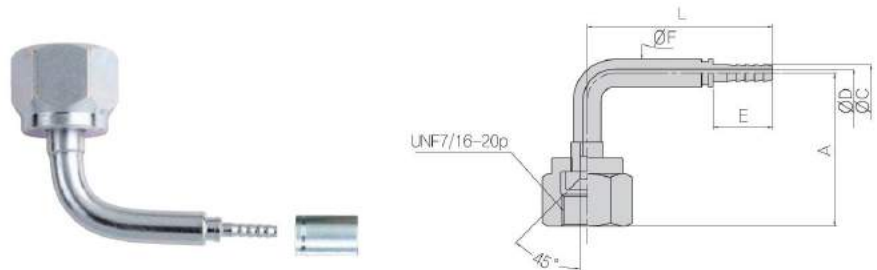

Specifications

Model No.	Hose	A (mm)	C (mm)	D (mm)	E (mm)	F (mm)	L (mm)	Socket	Material
RHL-01	RH-01	33.4	2.6	1.0	10.0	6.0	37.5	RHS-01	Steel

Tee Kit

[RH-01]

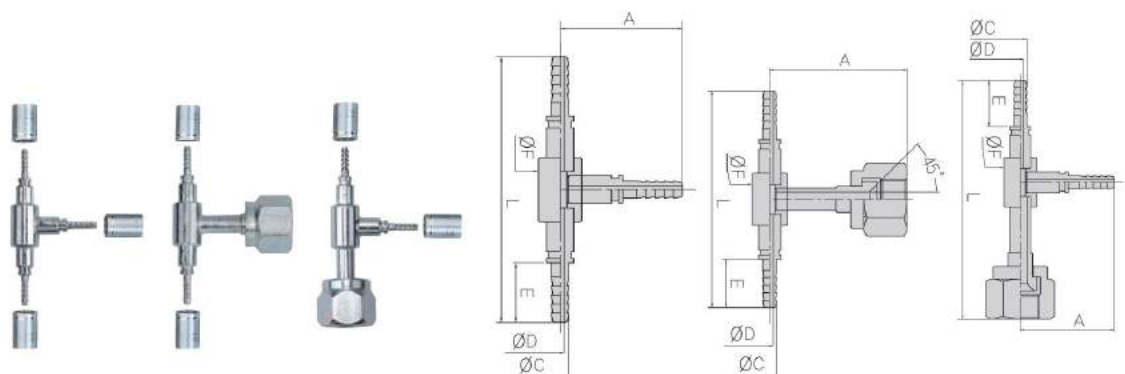

Specifications

Model No.	Hose	A (mm)	C (mm)	D (mm)	E (mm)	F (mm)	L (mm)	Socket	Material
RHUT-01	RH-01	24.0	2.6	1.0	10.0	9.5	52.0	RHS-01	Steel
RHT-01	RH-01	36.75	2.6	1.0	10.0	9.5	52.0	RHS-01	Steel
RHST-01	RH-01	24.0	2.6	1.0	10.0	9.5	65.0	RHS-01	Steel

Fitting by NP-4

NP-4 is by air pressure for RH-01, 02 and 04, three hoses. It's small and light crimping machine which measurement is 40x35x25(H)cm and weight is about 30kg.



- Booster Type : Direct Pressure Type
- Booster Cylinder : 150 Ø
- Pressure : 12.5Mpa
- Booster Ration : 1:25
- Jig Cylinder : 63 Ø
- Voltage : 220V
- Air Pressure : 0.5~0.8Mpa

Straight Fitting

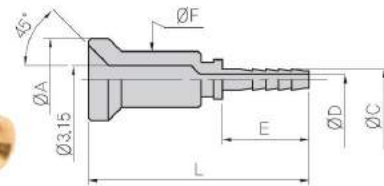

Specifications

Model No.	Hose	A (mm)	C (mm)	D (mm)	E (mm)	F (mm)	L (mm)	Socket	Material
RHN-01	RH- 01	9.5	2.6	1.0	10.0	6.5	26.5	RHS-01	Brass
RHN-02	RH- 02	9.5	3.55	1.8	13.0	6.5	29.2	RHS-02	Brass
RHN-04-7/16	RH- 04	9.5	6.45	3.6	15.0	7.7	29.5	RHS-04	Brass
RHN-04-5/8		14.0							

Model No.	Hose	A (HEX)	C (mm)	L (mm)	T (Thread)	Material
N7/16	RH- 01	17	6.7	15	UNF7/16-20	Brass
	RH- 02					
N7/16-04	RH- 04	17	7.9	15	UNF7/16-20	Brass/Steel
N5/8-04	RH- 04	22	11.8	16	UNF5/8-18	Brass/Steel

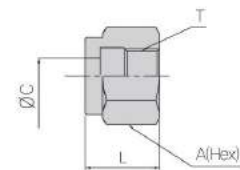

Socket

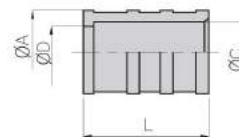

Specifications

Model No.	Hose	A (mm)	C (mm)	D (mm)	L (mm)	Material
RHS-01	RH- 01	8.0	5.7	4.8	12.0	Brass
RHS-02	RH- 02	10.0	7.2	5.9	15.0	Brass
RHS-04	RH- 04	13.8	10.7	7.5	18.0	Brass

Elbow Fitting

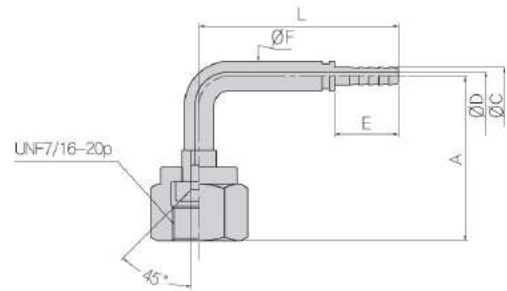

Specifications

Model No.	Hose	A (mm)	C (mm)	D (mm)	E (mm)	F (mm)	L (mm)	Socket	Material
RHL-01	RH-01	33.4	2.6	1.0	10.0	6.0	37.5	RHS-01	Steel
RHL-02	RH-02	33.4	3.55	1.8	13.0	6.0	40.5	RHS-02	Steel
RHL-UNF7/16-04	RH-04	33.4	6.45	3.6	15.0	6.0	42.5	RHS-04	Steel
RHL-UNF5/8-04		34.4							

Union Tee Fitting

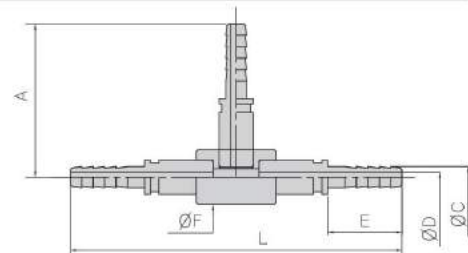

Specifications

Model No.	Hose	A (mm)	C (mm)	D (mm)	E (mm)	F (mm)	L (mm)	Socket	Material
RHUT-01	RH-01	24.0	2.6	1.0	10.0	9.5	52.0	RHS-01	Steel
RHUT-02	RH-02	26.5	3.55	1.8	13.0	9.5	58.0	RHS-02	Steel
RHUT-04	RH-04	31.0	6.45	3.15	15.0	12.0	67.5	RHS-04	Steel

Union Nut Tee Fitting

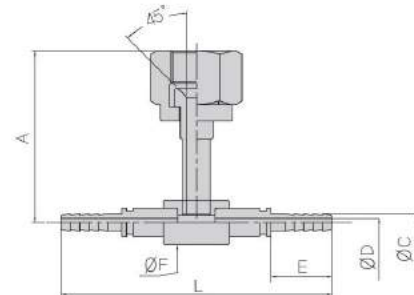

Specifications

Model No.	Hose	A (mm)	C (mm)	D (mm)	E (mm)	F (mm)	L (mm)	Socket	Material
RHT-01	RH-01	36.75	2.6	1.0	10.0	9.5	52.0	RHS-01	Steel
RHT-02	RH-02	36.75	3.55	1.8	13.0	9.5	58.0	RHS-02	Steel
RHT-UNF7/16-04	RH-04	36.75	6.45	3.6	15.0	12.0	67.5	RHS-04	Steel
RHT-UNF5/8-04		37.75							

Union Nut Tee Fitting

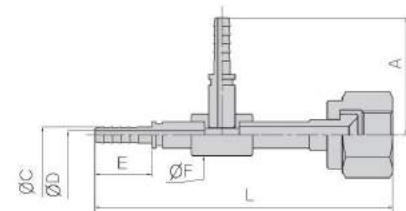

Specifications

Model No.	Hose	A (mm)	C (mm)	D (mm)	E (mm)	F (mm)	L (mm)	Socket	Material
RHST-01	RH-01	24.0	2.6	1.0	10.0	9.5	65.0	RHS-01	Steel
RHST-02	RH-02	26.5	3.55	1.8	13.0	9.5	68.0	RHS-02	Steel
RHST-UNF7/16-04	RH-04	31.0	6.45	3.6	15.0	12.0	74.5	RHS-04	Steel
RHST-UNF5/8-04		32.0							

Fitting by NP-9

NP-9 is hydraulic crimping machine for all RH model. Dies are compatible with each hose and Pushers follow fitting sizes and types.

- Layout : 400 x 610 x 963(H)mm
- Motor : 220V / 380V, 1.5w
- Oil pump : 200Bar, 3.15CC/rev
- Oil Tank : 4ℓ
- Cylinder : Ø 80 x 200St



Straight Fitting

[Flare type]

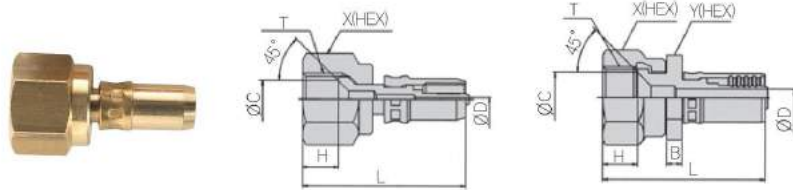

Specifications

Model No.	Hose	T	B (mm)	C (mm)	D (mm)	H (mm)	L (mm)	X (HEX)	Y (HEX)	Weight (g)	Pusher	Die
RHC-UNF7/16-01	RH-01	7/16-20UNF	-	8	0.9	8	33.5	17	-	30	PRHC-01	SP-RH-01
RHC-UNF7/16-02	RH-02	7/16-20UNF	4	7.5	1.8	9.8	41	17	14	38	PSK7/16-02-S	SP-RH-02
RHC-UNF5/8-02		5/8-18UNF	4	13	1.8	9.5	41	22	19	46	PRH5/8-06	SP-RH-02

Elbow Fitting

[Flare type]

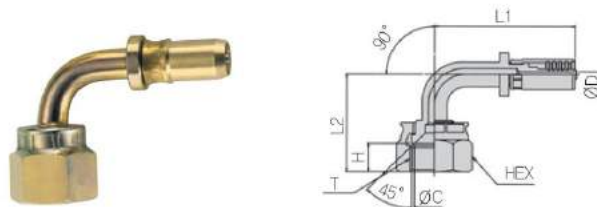

Specifications

Model No.	Hose	T	C (mm)	D (mm)	H (mm)	L ₁ (mm)	L ₂ (mm)	HEX	Weight (g)	Pusher	Die
RH90-UNF7/16-01	RH-01	7/16-20UNF	8	1.2	10	39	30	17	33	PAE-02N	SP-RH-01
RH90-UNF7/16-02	RH-02	7/16-20UNF	8	1.8	10	41	30	17	35	PAE-02N	SP-RH-02
RH90-UNF5/8-02		5/8-18UNF	13	1.8	9.5	45	32	22	50	PAF-14-04N	SP-RH-02

Union Tee Fitting

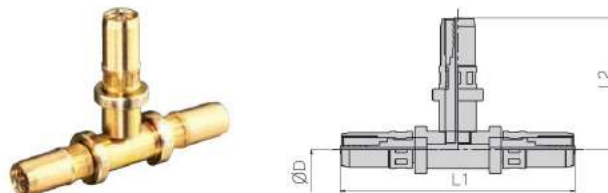

Specifications

Model No.	Hose	D (mm)	L ₁ (mm)	L ₂ (mm)	Weight (g)	Pusher	Die
SRHUT-01	RH-01	1.2	60	33.8	39	NPTP-01	SP-RH-01

Union Nut Tee Fitting

[Flare type]

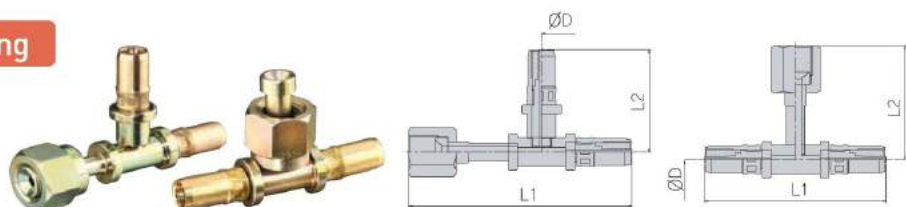

Specifications

Model No.	Hose	T	D (mm)	L ₁ (mm)	L ₂ (mm)	HEX	Weight (g)	Pusher	Die
SRHST-01	RH-01	7/16-20UNF	1.2	74	33.8	17	49	NPTP-01	SP-RH-01
SRHT-01	RH-01	7/16-20UNF	1.2	120	37.5	17	49	NPTP-01	SP-RH-01

Fitting of Truck Refrigeration Unit



Straight Fitting

[O-Ring type]

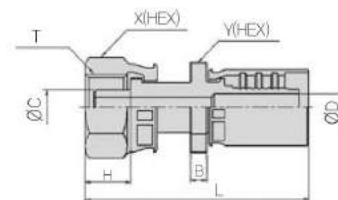

Specifications

Model No.	Hose	T	H (mm)	B (mm)	C (mm)	D (mm)	L (mm)	X (HEX)	Y (HEX)	Weight (g)	Pusher	Die
RHO-UNF5/8-06	RH-06	5/8-18UNF	9.5	4	8.55	6.8	63	22	19	79	PRH5/8-06	SP-14-06
RHO-UNF3/4-08	RH-08	3/4-16UNF	10.8	4	11.65	9.6	65	24	22	105	PRH3/4-08	SP-RH-08
RHO-UNF7/8-10	RH-10	7/8-14UNF	12.9	4.5	14.45	12.7	73	27	27	148	PRH7/8-10	SP-RH-10

Elbow Fitting

[O-Ring type]

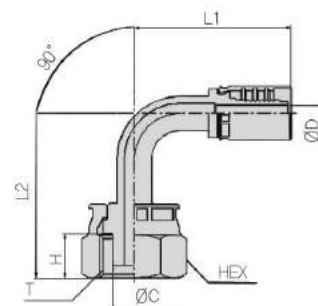

Specifications

Model No.	Hose	T	H (mm)	C (mm)	D (mm)	L ₁ (mm)	L ₂ (mm)	HEX	Weight (g)	Pusher	Die
RHO90-UNF5/8-06	RH-06	5/8-18UNF	9.5	8.55	6.8	63	45	22	90	PRH90-06	SP-14-06
RHO90-UNF3/4-08	RH-08	3/4-16UNF	10.8	11.65	9.6	70	48	24	148	PAF-14-08N	SP-RH-08
RHO90-UNF7/8-10	RH-10	7/8-14UNF	12.9	14.45	12.7	74	59	27	202	PRH90-10	SP-RH-10

Straight Fitting

[Flare type]

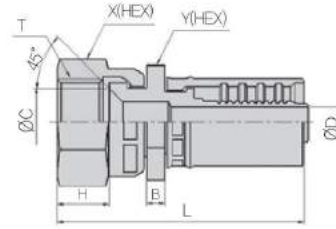

Specifications

Model No.	Hose	T	H (mm)	B (mm)	C (mm)	D (mm)	L (mm)	X (HEX)	Y (HEX)	Weight (g)	Pusher	Die
RHC-UNF7/16-04	RH-04	7/16-20UNF	9.8	4	7.5	3.5	40	17	14	40	PSK7/16-02-S	SP07-04
RHC-UNF5/8-04		5/8-18UNF	9.5	4	13	3.5	40	22	19	48	PRH5/8-06	SP07-04
RHC-UNF5/8-06	RH-06	5/8-18UNF	9.5	4	13	6.8	50	22	19	69	PRH5/8-06	SP-14-06
RHC-UNF3/4-06	RH-06	3/4-16UNF	10.8	4	14.5	6.8	53	24	22	77	PRH3/4-08	SP-14-06
RHC-UNF3/4-08	RH-08	3/4-16UNF	10.8	4	14.5	9.6	53	24	22	93	PRH3/4-08	SP-RH-08
RHC-UNF7/8-08	RH-08	7/8-14UNF	12.9	4.5	17.3	9.6	60	27	22	110	PRH7/8-10	SP-RH-08
RHC-UNF7/8-10	RH-10	7/8-14UNF	12.9	4.5	17.3	12.7	60	27	27	127	PRH7/8-10	SP-RH-10
RHC-UNS1-1/16-10	RH-10	1-1/16-14UNS	16	4.5	21.8	12.7	59	32	27	140	PSK1-08	SP-RH-10
RHC-UNS1-1/16-12	RH-12	1-1/16-14UNS	16	4.5	21.8	15.9	62	32	32	156	PSK1-08	SP-RH-12

Elbow Fitting

[Flare type]

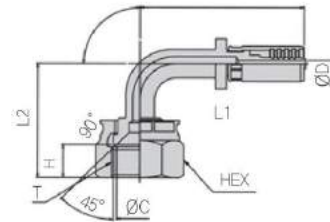

Specifications

Model No.	Hose	T	H (mm)	C (mm)	D (mm)	L ₁ (mm)	L ₂ (mm)	HEX	Weight (g)	Pusher	Die
RH90-UNF7/16-04	RH-04	7/16-20UNF	10	8	3.5	44	32	17	45	PAF-14-04N	SP07-04
RH90-UNF5/8-04		5/8-18UNF	9.5	13	3.5	44	32	22	56	PAF-14-04N	SP07-04
RH90-UNF5/8-06	RH-06	5/8-18UNF	9.5	13	6.8	63	45	22	84	PRH90-06	SP-14-06
RH90-UNF3/4-06	RH-06	3/4-16UNF	10.8	14.5	6.8	69	48	24	124	PAF-14-08N	SP-14-06
RH90-UNF3/4-08	RH-08	3/4-16UNF	10.8	14.5	9.6	70	48	24	134	PAF-14-08N	SP-RH-08
RH90-UNF7/8-08	RH-08	7/8-14UNF	12.9	17.3	9.6	75	59	27	187	PRH90-10	SP-RH-08
RH90-UNF7/8-10	RH-10	7/8-14UNF	12.9	17.3	12.7	74	59	27	173	PRH90-10	SP-RH-10

Straight Fitting

[Male type]

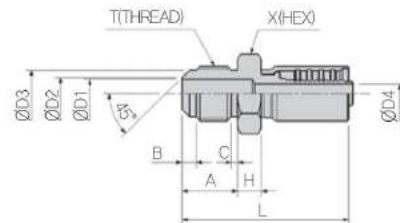

Specifications

Model No.	Hose	T	X (HEX)	L (mm)	H (mm)	A (mm)	B (mm)	C (mm)	D ₁ (mm)	D ₂ (mm)	D ₃ (mm)	D ₄ (mm)	Weight (g)	Pusher	Die
RHMC-UNF7/16-04	RH-04	7/16-20UNF	17	40	5.5	14	3.2	2	4.5	5.6	8.8	3.5	30	PRHMC-7/16-04	SP07-04
RHMC-UNF5/8-04		5/8-18UNF	21	43	6	17	4.8	2	7	8	13.5	3.5	46	PRHMC-5/8-04	SP07-04
RHMC-UNF3/4-06	RH-06	3/4-16UNF	24	57	8	19	4.8	2.2	10	11.2	16.3	6.8	80	PRHMC-3/4-06	SP-14-06
RHMC-UNF7/8-08	RH-08	7/8-14UNF	27	62	8	21	5	3	12.5	13.5	19.1	9.6	112	PRHMC-7/8-08	SP-RH-08

Fitting of Rotalock Valve Connection



R404A

R407c

Straight Fitting

[Female type]

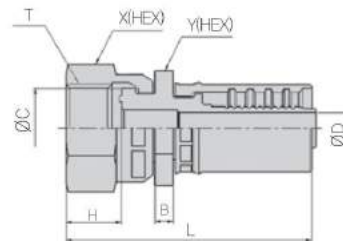

Specifications

Model No.	Hose	T	H (mm)	B (mm)	C (mm)	D (mm)	L (mm)	X (HEX)	Y (HEX)	Weight (g)	Pusher	Die
RHF-UNF3/4-06	RH-06	3/4 - 16UNF	11.2	4	17.3	6.8	53	24	22	78	PRH3/4-08	SP-14-06
RHF-UNS1-08	RH-08	1- 14UNS	12.5	4.5	24.9	9.6	59	32	27	141	PSK1-08	SP-RH-08
RHF-UNS1-10	RH-10	1- 14UNS	12.5	4.5	24.9	12.7	59	32	27	149	PSK1-08	SP-RH-10
RHF-UNF1-1/4-12	RH-12	1-1/4 - 12UNF	12.5	4.5	31.2	15.9	62	41	36	234	PSK1-1/4-12	SP-RH-12

Straight Fitting

[Male type]

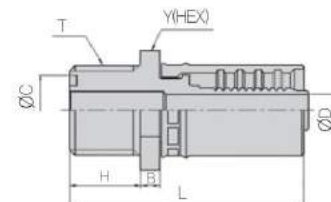

Specifications

Model No.	Hose	T	H (mm)	B (mm)	C (mm)	D (mm)	L (mm)	X (HEX)	Y (HEX)	Weight (g)	Pusher	Die
RHM-UNF3/4-06	RH-06	3/4 - 16UNF	15	4	14.7	6.8	49	24	22	65	PSA3/4-06	SP-14-06
RHM-UNS1-08	RH-08	1- 14UNS	15	4.5	19.5	9.6	52	32	27	104	PSA1-08	SP-RH-08
RHM-UNS1-10	RH-10	1- 14UNS	15	4.5	19.5	12.7	52	32	27	110	PSA1-08	SP-RH-10
RHM-UNF1-1/4-12	RH-12	1-1/4 - 12UNF	15	4.5	25.6	15.9	57.2	41	36	156	PSA1-1/4-12	SP-RH-12

Elbow Fitting

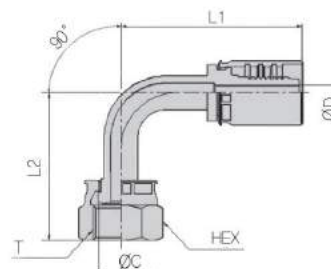
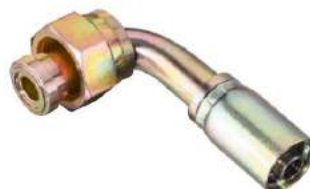

Specifications

Model No.	Hose	T	C (mm)	D (mm)	L ₁ (mm)	L ₂ (mm)	HEX	Weight (g)	Pusher	Die
RHF90-UNF3/4-06	RH-06	3/4 - 16UNF	13.75	6.8	68	48	24	105	PRH90-06	SP-14-06
RHF90-UNS1-08	RH-08	1- 14UNS	23	9.6	73	60	32	185	PAF-14-08N	SP-RH-08
RHF90-UNS1-10	RH-10	1- 14UNS	23	12.7	74	60	32	225	PRH90-10	SP-RH-10